

DESCRIPTION / DESCRIZIONE

en **The Otto collection, designed by Christophe Pillet, is born from an idea of clearness and essentiality: an immediate table that evidently expresses its function. The structure, defined by a double "T-shape" creates a strong and recognizable graphic signature. The metal leg, crafted with the precision of 3D laser cutting and available with upholstery too, yields a solid and architectural character, highlighting Mara's patented height adjustment mechanism. The thick cantilevered tops introduce a controlled lightness. Conceived for both the office and the home, Otto responds to the needs of a new generation with a clear, tactile, and contemporary design language. Otto Meeting Large is a large meeting table featuring a double powder-coated metal base, available in a wide range of colours and finishes to offer extensive customisation possibilities.**

it La collezione Otto, firmata da Christophe Pillet, nasce da un'idea di chiarezza ed essenzialità: un tavolo immediato che esprime in modo evidente la propria funzione. La struttura, definita da una doppia "forma a T", crea un segno grafico forte e riconoscibile. La gamba in metallo, realizzata con la precisione del taglio laser 3D e disponibile anche rivestita, in pelle o in tessuto, conferisce solidità e carattere architettonico, valorizzando il sistema meccanico di regolazione dell'altezza brevettato. I piani a sbalzo, dallo spessore importante, introducono una leggerezza controllata. Pensato per l'ufficio e per la casa, Otto risponde alle esigenze di una nuova generazione con un linguaggio progettuale chiaro, materico e contemporaneo. Otto Meeting Large è un grande tavolo riunioni con doppia base in metallo verniciato, proposto in numerose varianti di colore e finitura per offrire un'elevata possibilità di personalizzazione.

OTTO MEETING LARGE
sit-stand table
tavolo regolabile in altezza

289ML

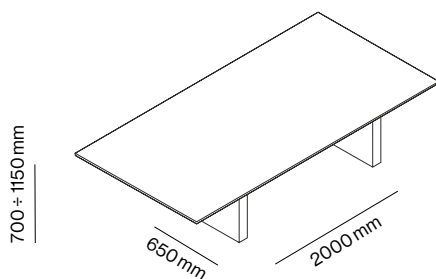

top
2600 - 3000 x 1200 - 1400 mm



patented system
sistema brevettato



adjustable height
altezza regolabile



fast
veloce



silent
silenzioso



no electricity
no elettricità



version with FSC® certified top
versione con piano certificato FSC®

ACCESSORIES / ACCESSORI

299FTI

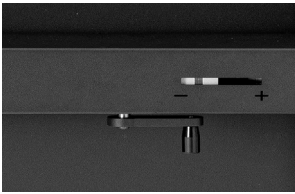

beam with loading adjuster
traversa con regolazione di portata

299FZ



counter balance kit
(2 zavorre 1,2 kg/cad.)
counter balance kit
(2 x 1,2 kg ballasts)

FP120x44 - FP180x44

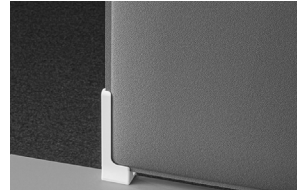

sound-absorbing panel, for fixing on top
pannello fonoassorbente, per fissaggio sopra piano

511PLUS



top access with flip cover
passacavi con sportello

511EPLUS



top access with multifunctional sockets
passacavi con prese multifunzione

PASD60



multifunctional sockets
Ø 60 mm
prese multifunzione
Ø 60 mm

PASD80



multifunctional sockets with wireless charging
Ø 80 mm
prese multifunzione con ricarica wireless Ø 80 mm

VERTEBRE



Flexible cable management
Vertebra flessibile in rete

300

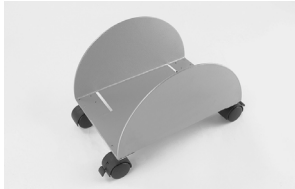

cpu holder
portaserver

500DROLL



mobile storage system, on castors
cassettiera mobile su ruote

FRAME / STRUTTURA

powder coated steel
acciaio verniciato



296
textured
raggrinzato
RAL 9010



819
textured
raggrinzato
RAL 8019



420
textured
raggrinzato



333
textured
raggrinzato
RAL 3003



111
textured
raggrinzato
RAL 5011



203
textured
raggrinzato
RAL 6003



700
textured
raggrinzato
RAL 7000



444
textured
raggrinzato
RAL 8004



301
textured
raggrinzato
RAL 7044



131
textured
raggrinzato
RAL 9006



148
textured
raggrinzato
RAL 7016



120
textured
raggrinzato
RAL 9005

TOP / PIANO

standard FENIX tops
piani standard in FENIX



0754
Blu
Fes



0791
Giallo
Evora



0751
Rosso
Jaipur



0750
Verde
Comodoro



0719
Beige
Luxor



0789
Rosso
Namib



0032
Bianco
Kos



0720
Nero
Ingo

STANDARDS AND CERTIFICATES / NORME E CERTIFICATI

Resistance to scratching EN 438-2:2019 - CL.25 Class ≥ 4 • Resistance to staining EN 438-2:2019 - CL.26 Group 1 e 2: Class 5 Group 3: Class ≥ 4 • Resistance to dry heat (160°C/20') - EN 438-2:2019 - CL.16 Class 5 • Lightfastness (xenon arc) EN 438-2:2019 - CL.27 Grayscale classification ≥ 4 • Resistance to steam EN 438-2:2019 - CL.14 Class 5 • Specular surface

reflection ISO 2813 8 ÷ 16 a 85° Unità Gloss • Resistance to surface wear EN 438-2:2019 - CL.10 Rotation value IP ≥ 200 • Resistance to damp heat (100°C/20') - EN 438-2:2019 - CL.18 Class 5

TOP / PIANO

standard colour and material effect laminate tops
piani standard in laminato colore ed effetto materico

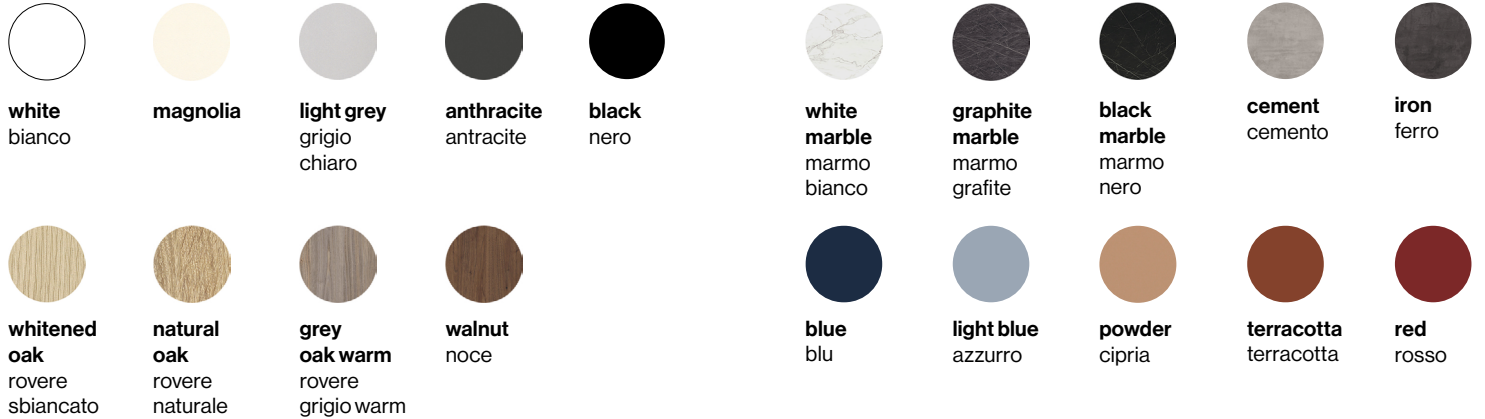

STANDARDS AND CERTIFICATES / NORME E CERTIFICATI
Dimensional tolerance related to the thickness $\pm 0,3$ mm • Dimensional tolerance related to the sizes $\pm 5,0$ mm • Resistance to scratching EN 438-2:2016 Class 3 • Resistance to staining EN 438-2:2016 Group 1 e 2: Class ≥ 4 Group 3: Class ≥ 4 • Resistance to dry heat (160°C/20') - EN 438-2 Class 4 • Lightfastness (xenon arc) EN 438-2 Grayscale classification ≥ 4

• Resistance to steam EN 438-2 Class 4 • Resistance to surface wear EN 438-2 Rotation value IP ≥ 150 • Resistance to damp heat (100°C/20') - EN 438-2 Class 4

standard colour and material effect melamine tops
piani standard in nobilitato colore ed effetto materico

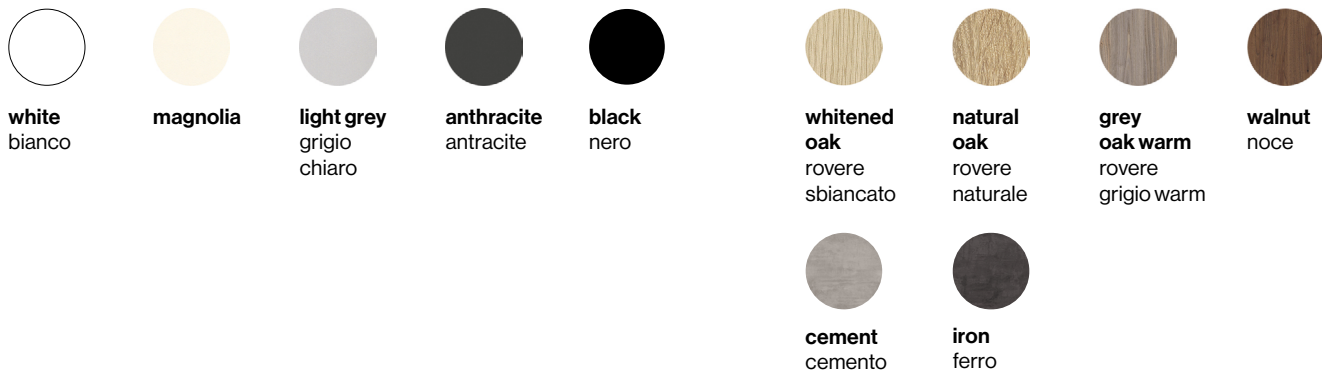

STANDARDS AND CERTIFICATES / NORME E CERTIFICATI
Dimensional tolerance related to the sizes $\pm 5,0$ mm • Resistance to scratching 1,5 N • Resistance to cigarette burning 3 grade - moderate change in gloss level and/or moderate brown spots • Resistance to surface wear Rotation value IP < 50 Rotation value WR < 150 • Risk of breakage ≥ 3 group • Dimensional tolerance related to the thickness $15 \leq X \leq 20$ mm : $\pm 0,3$ mm X < 20 mm : $\pm 0,5$ mm • Resistance to staining ≥ 3 group • Resistance to steam

4 grade - moderate change in gloss level and/or color • Surface imperfections Prolate imperfections: < 20 mm/m Punctiform imperfections: < 2 mm²/m² • Lightfastness (xenon arc) > 6 group

UPHOLSTERIES / RIVESTIMENTI

CAT. D, ZERO - KVADRAT

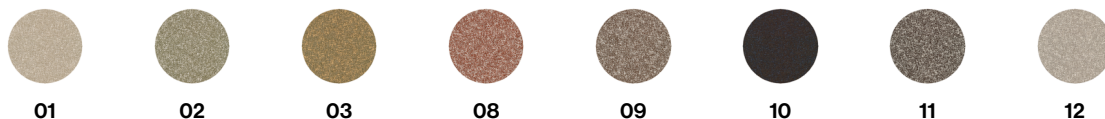

COMPOSITION / COMPOSIZIONE

65% cotton 20% polyacrylic 15% polyester

WEIGHT / PESO

740 g/m lin. (23,87 oz/ly)

ABRASION RESISTENCE / RESISTENZA ABRASIONE

Approx. 70.000 Rubs Martindale (EN ISO 12947)

TEST / TEST

note 5, EN ISO 12945 • Seam parallel to warp: 2.0 mm, parallel to weft: 2.0 EN ISO 13936-2 180 Newton • Note 5-6 ISO 105-B02 • Dry note 4-5 ISO 105-X12, Wet note 4-5 ISO 105-X12 • AS/NZS 3837 Class 2, BS 5852 Crib 5 with treatment, BS 5852 part 1 with treatment, EN 1021-1, US Cal. Bull. 117-2013 with cAL.117 compliant interliner • US Cal. Bull. 117-2013 with Cal. 117 compliant interliner • AATCC8 Dry Croking: Grade 4.5, Wet Croking: Grade 4 • AATCC

16 Grade 5 min. 40h • Pilling Clas 5.0, Breaking Strenght ASTM D5034 warp 159 / weft 113 lbs, Seam Slippage ASTM D4034 warp 91 / weft 22 lbs • ASTM D4966 70.000 cycles Martindale - High Traffic.

CLEANING RULES / NORME DI PULIZIA

Vacuum frequently, ideally every week, at half power where appropriate. Wipe upholstery fabrics made from polyurethane with a dry or moist cloth. May also be vacuum cleaned with a soft brush. Disinfection, see kvadrat.dk

Passare spesso l'aspirapolvere ove opportuno, se possibile ogni settimana, a potenza intermedia. Pulire i tessuti per tappezzeria in poliuretano con un panno asciutto o umido o anche usando un aspirapolvere con spazzola morbida. Disinfezione, vedi kvadrat.dk

CAT. D, VERA PELLE, PRIMALINEA - MASTROTTO

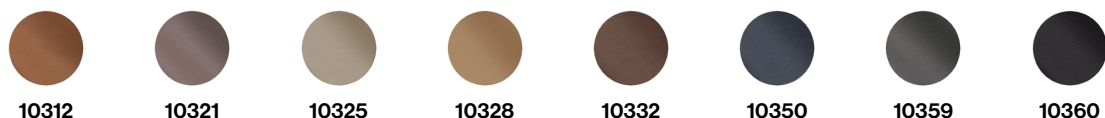

COMPOSITION / COMPOSIZIONE

100% Nappa

ABRASION RESISTENCE / RESISTENZA ABRASIONE

50.000, UNI EN ISO 5402 - No damage

TEST / TEST

Tear strength (single edge tear) UNI EN ISO 3377-1 N \geq 20 • Colour fastness to rubbing (dry, 500 cycles) UNI EN ISO 11640:1998 Grey scale \geq 4 • Colour fastness to rubbing (wet, 250 cycles) UNI EN ISO 11640:1998 Grey scale \geq 4 • Colour fastness to rubbing (sweat, 80 cycles) UNI EN ISO 11640:1998 ISO 11641 pH8 Grey scale \geq 4 • Finish adhesion (dry) UNI EN ISO 11644 N/cm \geq 2 • Color fastness to artificial light (exp. energy 16.000 kj/sqm) UNI EN ISO 105 B02 (MET. 5) Blue scale \geq 5 • Smolder resistance, cigarette and match flame CAL TB-117 (2013, Sec. 1) BS 5852: 1979, source 0-1 BS EN 1021-1-2:2006-Pass • Measurement of antibacterial activity on non-porous surfaces ISO 22196 Anti-bacterial efficacy • Test method to assess antibacterial activity

ISO 16187 Anti-bacterial efficacy • Standard test method for determining the antimicrobial activity of antimicrobial agents under dynamic contact conditions ASTM E 2149 Anti-bacterial efficacy • Standard test method for determining the activity of incorporated antimicrobial agent(s) in polymeric or hydrophobic materials ASTM E 2180 Anti-bacterial efficacy • Determination of antiviral activity ISO 18184 Anti-viruses efficacy

CLEANING RULES / NORME DI PULIZIA

Avoid direct sunlight. Avoid exposure to heat sources.

Evitare la luce diretta del sole. Evitare l'esposizione alle fonti di calore.

FIRE RETARDANT UPHOLSTERIES / RIVESTIMENTI IGNIFUGHI



CAT. C, REMIX 3 - KVADRAT



163 123 143 933 452 173 242 733 346 612

COMPOSITION / COMPOSIZIONE

90% new wool, 10% nylon

WEIGHT / PESO

420 g/lin.m, 13.6 oz/ly

ABRASION RESISTENCE / RESISTENZA ABRASIONE

100.000 Martindale rubs, EN ISO 12947

FIRE RETARDANT TEST / TEST IGNIFUGO

AS/NZS 1530.3 • BS 5852 crib 5 with treatment • BS 5852 part 1 • IMO FTP Code 2010 Part 7 with treatment • IMO FTP Code 2010 Part 8 • NF D 60 013 • NFPA 260 • SN 198 898 5.3 with treatment • UNI 9175 1IM • US Cal. Bull. 117-2013 • EN 1021-1/2 • AS/NZS 3837 class 2 • ÖNORM B1/Q1 • ASTM E84 Class A Unadhered • ASTM E84 Class A Adhered • GB 50222 B1 with treatment (Chinese) • EN 13501 B-s2, d0 with treatment

CLEANING RULES / NORME DI PULIZIA

Vacuum clean frequently, ideally every week. Remove stains as soon as they occur, with clean warm water or sparkling water. Extraction clean when necessary. Extraction cleaning might dissolve water-based glue. Pay attention to temperature and amount of cleaning fluid. Disinfection, see kvadrat.dk

Passare spesso l'aspirapolvere, possibilmente ogni settimana. Rimuovere le macchie non appena si formano, con acqua calda pulita o acqua calda o frizzante. Pulire a estrazione quando necessario. La pulizia a estrazione può sciogliere la colla a base d'acqua. Prestare attenzione alla temperatura e alla quantità di liquido detergente. Disinfezione, vedi kvadrat.dk

CAT. C, FIELD 2 - KVADRAT

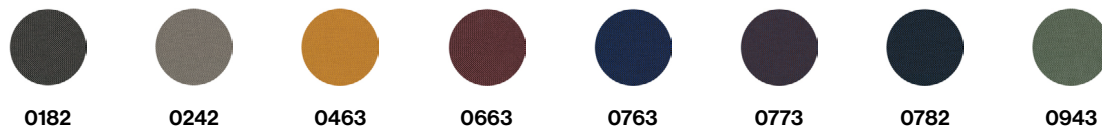

0182 0242 0463 0663 0763 0773 0782 0943

COMPOSITION / COMPOSIZIONE

100% Trevira CS

WEIGHT / PESO

450 g/lin. m (14.51 oz/ly)

ABRASION RESISTENCE / RESISTENZA ABRASIONE

80.000 Rubs Martindale (EN ISO 12947)

FIRE RETARDANT TEST / TEST IGNIFUGO

NF D 60 013 • US Cal. Bull. 117-2013 • NFPA 701 • BS 5852 Crib 5 • EN 1021-1/2 • AS/NZS 3837 class 1 • IMO FTP Code 2010 Part 8 • DIN 4102 B1 • NF P 92 507 M1 • FAR 25.853 • UNI 9175 1IM • UNI 9177 Classe 1 • BS 5867 part 2 type B • SN 198 898 5.2 • EN 13501-1, B-s1, d0 • ÖNORM B1/Q1 • CAN ULC S102 • CAN ULC S109 • IMO FTP Code 2010 Part 5 • GB 8624 B1 • ASTM E84 Class A Unadhered

CLEANING RULES / NORME DI PULIZIA

Vacuum clean frequently, ideally every week. Remove stains as soon as they occur, with clean warm water or sparkling water. Extraction clean when necessary. Extraction cleaning might dissolve water-based glue. Pay attention to temperature and amount of cleaning fluid. Disinfection, see kvadrat.dk

Passare spesso l'aspirapolvere, possibilmente ogni settimana. Rimuovere le macchie non appena si formano, con acqua calda pulita o acqua calda o frizzante. Pulire a estrazione quando necessario. La pulizia a estrazione può sciogliere la colla a base d'acqua. Prestare attenzione alla temperatura e alla quantità di liquido detergente. Disinfezione, vedi kvadrat.dk

OTTO MEETING LARGE / design Christophe Pillet
289ML

mara

CAT. C, CAPTURE - GABRIEL



3001



3601



3701



3801



4601



5101



6601



7401

COMPOSITION / COMPOSIZIONE

85% New Zealand wool, 15% Polyamide

WEIGHT / PESO

475 g/lm — 15.32 oz./lin.yd

ABRASION RESISTENCE / RESISTENZA ABRASIONE

200,000 — rubs martindale (EN ISO 12947-2)

200,000 — rubs martindale (ASTM D4966) (heavy duty upholstery)

FIRE RETARDANT TEST / TEST IGNIFUGO

BS EN 1021 1&2 Cigarette and Match • BS 5852 Part 10,1 Cigarette & Match, The Furniture and Furnishing Regulations 1988 • Class Uno UNI 9175 Class 1 EMME • CA TB 117-2013 • ASTM E 84 Class 1

FIRE RETARDANT UPHOLSTERIES / RIVESTIMENTI IGNIFUGHI

CAT. C, CAPTURE - GABRIEL

4601510166017401

3001360137013801

CLEANING RULES / NORME DI PULIZIA

Always follow the manufacturer's instructions and finish by wiping with a damp cloth.

Seguire sempre le istruzioni del produttore e finire con un panno umido.

CAT. B, BOUCLÉ



911



913



904



307



400



201



707



600



502



801

COMPOSITION / COMPOSIZIONE

100% Polyester with FR backing

WEIGHT / PESO

1020 g/ml +/- 8%

ABRASION RESISTENCE / RESISTENZA ABRASIONE

ISO 12947-2 / ≥80.000 cicli / rubs martindale • ASTM D4157 / ≥80.000 cicli / rubs martindale

CERTIFICATIONS / CERTIFICAZIONI

EN 1021/1 (cigarette) - 2 (match) • BS 5852-1 (cigarette) - (match) • BS 5852 (CRIB 5) UNI 9175, classe 1 • IM CAL TB 117 NFPA 260 • IMO 2010 FTP part 8 ISO 105 - B02 / ≥4-5 (scale 1-8) • AATCC 16.3 / (40 afu) / ≥3-4 (scale 1-5)

• ISO 12945 / ≥4-5 (scale 1-5) • ISO 105 x 12 / dry ≥4-5 / wet ≥3-4 (scale 1-5)
• AATCC 8 / dry ≥4-5 / wet ≥3-4 (scale 1-5) ISO 105 - E03 / (scale 1-5) ISO 105 - E02 / (scale 1-5) • ISO 13936 - 2 / warp ≤6,00 mm. / weft ≤6,00 mm. • ASTM D4034 / ≥60 lbs.

CLEANING RULES / NORME DI PULIZIA

Vacuum regularly with a smooth nozzle, without brushing.

Usare con regolarità l'aspirapolvere a beccuccio liscio, senza spazzolare.

OTTO MEETING LARGE / design Christophe Pillet
289ML

mara

CAT. B, STEP MELANGE - GABRIEL



60004



60011



60021



67007



65090



64159



68120



65011

COMPOSITION / COMPOSIZIONE

100% Trevira cs

WEIGHT / PESO

470 g/lm, 15,16 oz/lin.yd

ABRASION RESISTENCE / RESISTENZA ABRASIONE

100.000 rubs martindale (EN ISO 12947-2), 100,000 double rubs wyzenbeek (ASTMD4157-07) (heavy duty upholstery)

FIRE RESISTANCE / RESISTENZA AL FUOCO

DIN 4102 - B1 • NFP 92-503/504/505 M1 • BS EN 1021 1&2 Cigarette and Match • BS EN 1021-1 Cigarette • BS 5852 Crib 5 • ÖNORM A3800-B1-B3825-Q1 UK • FAR/JAR 25.853 (a) (i) (ii) • AM 18 - NFD 60-013-(only for fabric) • CA TB 117-2013 • Class Uno UNI 9175 Class 1I EMME • DIN EN 13501-1 B-s1,d0 • IMO MSC 307(88) Annex 1 part 8 • MED Certificate IMO • IMO MSC 307(88) Annex 1 part 8 UK • MED Certificate IMO UK • CAN/ULC-S102.2 • CAN/ULC-S 109

CLEANING RULES / NORME DI PULIZIA

Step Melange is made of Trevira CS which is a polyester material suited for environments with special requirements for cleaning. Can be wiped with Virkon S, Actichlor Plus, Prime Source ren-93 or Ethanol (70-85%). Always follow the manufacturer's instructions and finish by wiping with a damp cloth.

Step Melange è realizzato in Trevira CS, un materiale in poliestere adatto ad ambienti con particolari esigenze di pulizia. Può essere pulito con Virkon S, Actichlor Plus, Prime Source ren-93 o etanolo (70-85%). Seguire sempre le istruzioni del produttore e finire con un panno umido.

CAT. B, FENICE - PUGI



601



602



603



452



301



505

COMPOSITION / COMPOSIZIONE

75% WO 25% PA

WEIGHT / PESO

335 ± 7% / 500 ± 7% gr./m²-gr./mtl.

ABRASION RESISTENCE / RESISTENZA ABRASIONE

100.000 ± 20% cicli (UNI EN ISO 12947)

CERTIFICATIONS / CERTIFICAZIONI

Misura del coefficiente di assorbimento acustico UNI EN ISO 354:2003 • Rapporto di misura del coeff. di assorbimento acustico UNI EN ISO 10534-2 • Rapp.di Prova Classe 1IM-con schiuma standard ignifuga con densità 25 kg3 • BS 5852 Crib N°5 with standard Foam 20/22 Kg/cu.m-CON TRATT. A RICHIESTA • EN 1021 Part 1-2 using a standard Foam 20/22 Kg/cu.m. • Calif. Bull.117 June 2013

CLEANING RULES / NORME DI PULIZIA

Vacuum regularly with a smooth nozzle, without brushing.

Usare con regolarità l'aspirapolvere a beccuccio liscio, senza spazzolare.

OTTO MEETING LARGE / design Christophe Pillet
289ML

mara

Cat. A, VELVET



14406



16430



16040



14423



16610



14438



16425

COMPOSITION / COMPOSIZIONE

100% inherent FR polyester

WEIGHT / PESO

Weight 325 g/m² | 9.59 oz/yd² • Width 138-140 cm | 54" • Piece length ± 49 m
| 53 yd • Dye batch length ± 200 m | 218 yd

ABRASION RESISTENCE / RESISTENZA ABRASIONE

50.000 cycles MARTINDALE

CERTIFICATIONS / CERTIFICAZIONI

Breaking strength ISO 13934-1 Warp 1200N Weft N 820N • Tear resistance

EN ISO 13937-3 Of the warp 49N Of the weft 37N • Seam slippage ISO 13936-2 Warp 1.50 mm Weft 1.00 mm • Abrasion resistance ISO 12947-2 Colour degradation at 3000 rubs 4 - 5 Complete wear out 60.000 rubs • Colour fastness to light EN ISO 105 B02 Colour 5 - 6 • Colour fastness to rubbing EN ISO 105-X12 Dry 4 - 5 Wet 4 - 5 • Fastness to water EN ISO 105-E01 Colour 4 • Dimensional change in domestic washing and drying EN ISO 5077 Warp 0.5% EN ISO 6330 Weft 0.5%

CLEANING RULES / NORME DI PULIZIA

Clean with damp soapy cloth and rinse well with clean water. Do not use solvents, bleaches, synthetic detergents, polishes or aerosol spray.

Pulire con tessuto inumidito ed insaponato e sciacquare bene con acqua pulita. Non usare solventi, candeggine e detergenti chimici o spray per lucidare.

CAT. A, ECO-LEATHER GAZEBO - LEDERPLAST



06



151



1194



6986



4981



726



991

COMPOSITION / COMPOSIZIONE

87,5% P.V.C. Plastificato, 8,1% Poliestere, 4,4% Cotone

WEIGHT / PESO

640 ± 50 g/m² (UNI EN 2286-2:2001)

ABRASION RESISTENCE / RESISTENZA ABRASIONE

300.000 cicli (UNI EN ISO 5470-2:2004)

FIRE RESISTANCE / RESISTENZA AL FUOCO

UNI 9175: 2010 Reaction ignition of upholstered furniture exposed to a small flame CLASS 1IM • BS 1021-1: 2014 Assessment of the ignitability of upholstered furniture – Part 1: Ignition source smouldering cigarette • BS 1021-1: 2014 Assessment of the ignitability of upholstered furniture – Part 2: Ignition source match flame equivalent • BS 5852 parte 1: 1979 Match flame equivalent test • The material complies with the requirements of BS 7176:

2007+A1: 2011 for the hazard category LOW HAZARD • California Technical Bulletin 117:2013 • IMO Resolution MSC.307(88) - FTP CODE 2010 – PART 8 • AFNOR NF P 92.503 – M2 • ISO 3795: 1989 • FAR 25.853 Part 25 Appendix F Vertical test Par (a) (1) (ii)

CLEANING RULES / NORME DI PULIZIA

Clean with damp soapy cloth and rinse well with clean water. Do not use solvents, bleaches, synthetic detergents, polishes or aerosol spray.

Pulire con tessuto inumidito ed insaponato e sciacquare bene con acqua pulita. Non usare solventi, candeggine e detergenti chimici o spray per lucidare.

OTTO MEETING LARGE / design Christophe Pillet
289ML

mara

CAT. A, MIRAGE - PUGI



629



625



651



379



332



234



231



533



53



426

COMPOSITION / COMPOSIZIONE

100% PLFR (Tr Cs)

WEIGHT / PESO

330 ± 10% / 460 ± 10% gr./m²-gr./mtl.

ABRASION RESISTENCE / RESISTENZA ABRASIONE

100.000 ± 20% cicli (UNI EN ISO 12947:2000)

CERTIFICATIONS / CERTIFICAZIONI

Rapporto di misura della resistenza al flusso d'aria secondo la norma ISO 9053-2 • Classe 1 Sipari, Drappeggi, Tendaggi Classe 1IM - Rapporto di prova • EN ISO 6940/6941: BS 5852 Crib N°5 using a CM Foam 35 Kg/cu.m. • B1 DIN 4102. • EN 1021 Part 1-2 using a CM Foam 35 Kg/cu.m. • EN 13773

Burning Behaviour: Class 1 • EN 13501-1 esp 1,2 : B-s1, • Calif.Bull.117 June 2013 • Fire Protection Classification: 5.3 • M1 + NF D 60-013:2006 AM18 • FAR.25853 Classification: yes • B1 - OENORM 3800 PART 1 + OENORM B3825 • Azimut • MED/3.19 MED/3.21: Draperies, Curtains and Bedding comp • MED annex A.1 item:A.1/3.20 Upholstered Furniture

CLEANING RULES / NORME DI PULIZIA

Vacuum regularly with a smooth nozzle, without brushing.

Usare con regolarità l'aspirapolvere a beccuccio liscio, senza spazzolare.

TECHNICAL SPECIFICATION
289ML



- > Otto Meeting Large has a height range of 450 mm.
- > Excluding the table tops it has a minimum height of 700 mm and a maximum of 1150 mm.
- > Otto Meeting Large can be used with table tops from 2600 mm to 3000 mm wide and from 1200 mm to 1400 mm deep.
- > The table frame (2000x650 mm) is designed for optimal operation in a range of weights (top weight + accessories weight) between 57 and 65 kg.
- > Depending on the intended use of the table, carefully evaluate the weight of the table top to be assembled.
- > If a lighter table top is to be installed or if the table is to work without additional weight, the "counter-balance kit" is able to reduce 14,4 kg the upwards thrust allowing a correct functioning of the movement.

Meeting Large	min	max
height range (mm)	460	
frame height (mm)	700	1150
table top width (mm)	2600	3000
table top depth (mm)	1200	1400
table top weight + accessories recommended weight (kg)	57	65
counter-balance kit * (kg)	1,2	14,4

* optional

TOP WEIGHTS					TOP + RECOMMENDABLE LOADING WEIGHT (kg)	
	Depth	Width			MIN	MAX
SINGLE TOP		2600 mm	2800 mm	3000 mm		
MELAMINE TOP 25 mm	1200 mm R600 / R150	45 kg	49 kg	53 kg	57	65
	1400 mm R700 / R150	52 kg	56 kg	61 kg		
LAMINATE AND FENIX TOP 20 mm	1200 mm R600 / R150	43 kg	47 kg	51 kg		
	1400 mm R700/ R150	50 kg	54 kg	58 kg		
LAMINATE AND FENIX TOP 27 mm	1200 mm R600 / R150	57 kg	62 kg	-		
	1400 mm R700 / R150	66 kg	-	-		
LAMINATE AND FENIX TOP 40 mm	1200 mm R1 / R2	63 kg	-	-		

PLEASE NOTE: OBSERVE THE WEIGHTS INDICATED

> A load, on the frame, exceeding the maximum weight indicated (top weight + accessories weight), causes a rapid lowering of the table top when unlocked.

> A load, on the frame, below the minimum weight indicated (top weight + accessories weight), causes an excessive upward thrust of the table when unlocked.

INSTRUCTIONS FOR CORRECT USE

FIRST USE:

A. Remove the safety-spacer from the adjustment handle (9a).

ONLY IF NECESSARY:

A. Unscrew the nut (11b) and adjust the handle cable (11c): a clockwise rotation will loosen it, while a counter clockwise rotation will tighten it out. The adjustment is correct when the handle is neither loose nor hard.

B. Secure the nut (11b) after adjusting the cable tension of the handle (11c).

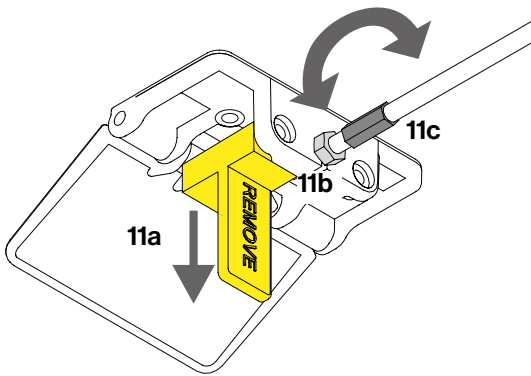

DAILY USE:

1. Place one hand on the adjustment handle and the other hand on the same side of the table top, and operate the movement (fig. 1).
2. Using both hands, lift or lower the top to the desired height.
3. The table is easily adjustable.
In case of difficult use, adjust the handles cable (see "only if necessary").
4. Once the desired height has been reached, stop the movement and release the handle.
The table will automatically lock in the desired position.

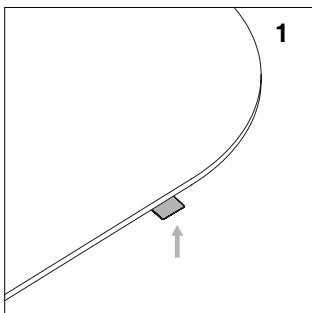

ATTENTION

Any part of all components already assembled and supplied by the company cannot be disassembled unless this is done by Mara personnel. The assembly and disassembly of this table must be carried out by skilled operator following the instructions carefully.

- > Otto Meeting Large ha un'escursione in altezza di 450 mm.
- > Escluso il piano ha un'altezza minima di 700 mm e una massima di 1150 mm
- > Otto Meeting Large può montare piani da 2600 mm a 3000 mm di larghezza e da 1200 mm a 1400 mm di profondità.
- > Il telaio del tavolo (2000x650 mm) è progettato per un funzionamento ottimale in un intervallo di pesi (peso piano + pesi accessori) compresi tra i 57 e i 65 kg.
- > In base all'utilizzo previsto del tavolo, valutare attentamente il peso del piano da montare.
- > Se è previsto il montaggio di un piano più leggero o non è previsto di caricare il piano di lavoro, l'accessorio "counter-balance kit" è in grado di ridurre fino a 14,4 kg la spinta verso l'alto permettendo il corretto funzionamento del movimento.

Meeting Large	min	max
escursione altezza (mm)	450	
altezza telaio (mm)	700	1150
larghezza piano (mm)	2600	3000
profondità piano (mm)	1200	1400
peso piano + peso accessori (kg)	57	65
counter-balance kit * (kg)	1,2	14,4

* opzionale

PESI PIANI					PIANO + CARICO CLIENTE PESO CONSIGLIATO (kg)	
	Profondità	Lunghezza			MIN	MAX
PIANO SINGOLO		2600 mm	2800 mm	3000 mm		
PIANO IN NOBILITATO SP 25 mm	1200 mm R600 / R150	45 kg	49 kg	53 kg	57	65
	1400 mm R700 / R150	52 kg	56 kg	61 kg		
PIANO IN LAMINATO E FENIX SP 20 mm	1200 mm R600 / R150	43 kg	47 kg	51 kg		
	1400 mm R700 / R150	50 kg	54 kg	58 kg		
PIANO IN LAMINATO E FENIX SP 27 mm	1200 mm R600 / R150	57 kg	62 kg	-		
	1400 mm R700 / R150	66 kg	-	-		
PIANO IN LAMINATO E FENIX SP 40 mm	1200 mm R1 / R2	63 kg	-	-		

ATTENZIONE: ATTENERSI AI PESI INDICATI

> Un carico sopra il telaio superiore al peso massimo indicato (peso piano + peso accessori) causa un veloce abbassamento del piano al momento dello sblocco.

> Un carico sopra il telaio inferiore al peso minimo indicato (peso piano + peso accessori) causa un veloce innalzamento del piano al momento dello sblocco.

ISTRUZIONI D'USO

AL PRIMO UTILIZZO:

A. Rimuovere il distanziale di sicurezza inserito nella maniglia di regolazione (11a).

SOLO SE NECESSARIO:

A. Svitare il dado (11b) e regolare il cavo della maniglia (11c): una rotazione oraria lo allenterà mentre una rotazione antioraria lo tenderà. La regolazione è corretta quando la maniglia non risulta nè libera ne troppo dura.

B. Fissare il dado (11b) una volta regolata la tensione del cavo (11c).

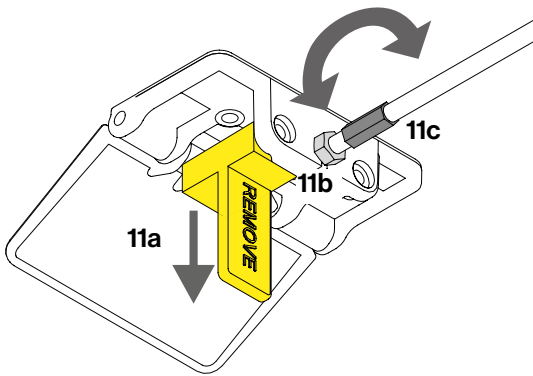

USO QUOTIDIANO:

1. Posizionare la mano d'utilizzo sulla maniglia di regolazione e l'altra mano sullo stesso lato del piano e azionare il movimento (fig. 1).
2. Utilizzando entrambe le mani, sollevare o abbassare il piano all'altezza desiderata.
3. Il tavolo si regola facilmente.
In caso di difficoltà nell'utilizzo, migliorare la regolazione del cavo della maniglia (vedi "solo se necessario").
4. Raggiunta l'altezza desiderata fermare il movimento e rilasciare la maniglia di regolazione.
Il tavolo si bloccherà automaticamente nella posizione desiderata.

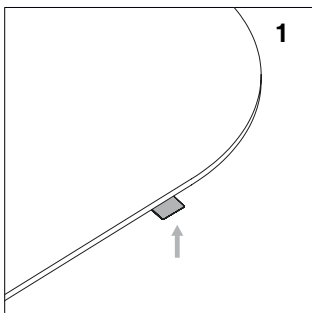

ATTENZIONE

Ogni componente fornito già montato dall'azienda non può essere smontato in nessuna sua parte se non da personale Mara. Montaggio e smontaggio di questo tavolo deve essere effettuato da personale esperto seguendo attentamente le istruzioni.

CLEANING AND MAINTENANCE / PULIZIA E MANUTENZIONE

STEEL / ACCIAIO

en Our types of metals include: chromed metals and painted metals. Do not use acid or alkaline based cleaning products. Do not use detergents, steel wool, dishwashing detergents or the like. Sharp or pointed objects may damage the surface. Any hot or wet object may cause surface damage. Clean the surface regularly with a soft cloth to remove dust. To remove light dirt, use a soft cloth and a neutral household cleaner.

it Le nostre tipologie di metallo comprendono: metalli cromati e metalli verniciati. Non utilizzare prodotti per la pulizia a base acida o alcalina. Non utilizzare detergenti, lana di acciaio, detersivi per stoviglie o simili. Oggetti appuntiti o taglienti possono danneggiare la superficie. Qualsiasi oggetto caldo o bagnato potrebbe provocare danni alla superficie. Pulire la superficie regolarmente con un panno soffice per rimuovere la polvere. Per rimuovere lo sporco leggero utilizzare un panno soffice e un prodotto per le pulizie di casa neutro.

CHROMED STEEL AND ALUMINIUM POLISHED / ACCIAIO CROMATO E ALLUMINIO LUCIDO

en Do not use acid or alkaline based cleaning products. Do not use detergents, steel wool, dishwashing detergents or the like. Sharp or pointed objects may damage the surface. Any hot or wet object may cause surface damage. Clean the surface regularly with a soft cloth to remove dust. To remove light dirt, use a soft cloth and a neutral household cleaner

it Non utilizzare prodotti per la pulizia a base acida o alcalina. Non utilizzare detergenti, lana di acciaio, detersivi per stoviglie o simili. Oggetti appuntiti o taglienti possono danneggiare la superficie. Qualsiasi oggetto caldo o bagnato potrebbe provocare danni alla superficie. Pulire la superficie regolarmente con un panno soffice per rimuovere la polvere. Per rimuovere lo sporco leggero utilizzare un panno soffice e un prodotto per le pulizie di casa neutro.

LAMINATE AND MELAMINE / LAMINATI E NOBILITATI

en Laminates and melamine products guarantee high performance in terms of resistance to scratches, shocks and abrasions. Keep furniture away from direct sunlight; furniture in direct sunlight may tend to discolour over time. Do not use acid or alkaline based cleaning products. Sharp or pointed objects can damage the surface. Laminate and melamine furniture can be cleaned using a mixture of liquid soap and hot water. Rinse with cold water and dry with a paper towel or damp cloth.

it Laminati e nobilitati garantiscono alte prestazioni di resistenza ai graffi, agli urti e alle abrasioni. Mantenere i mobili lontani dalla luce diretta del sole; i mobili che si trovano alla luce diretta del sole potrebbero tendere a scolorire nel tempo. Non utilizzare prodotti per la pulizia a base acida o alcalina. Oggetti appuntiti o taglienti possono danneggiare la superficie. E' possibile effettuare la pulizia dei mobili in laminato e nobilitato usando una miscela di sapone liquido e acqua calda. Sciacquare con acqua fredda e asciugare con un tovagliolo di carta o un panno umido.

STANDARD FENIX TOPS / PIANI STANDARD IN FENIX

en Cleaning FENIX means cleaning its structure. You can do this with warm water. As FENIX is a strong material, you can also use any household cleaner – even solvents like acetone * if needed. However, to avoid damaging the structure, don't scrub it with abrasive cream, a scouring pad or a hard brush; in the long-term, this might lead to a glossy spot on your matt surface. Instead, you can use a melamine sponge – also known as a magic sponge. As a final step, to avoid anything staying behind in the structure – whether that's dirt or residue from your cleaner – always rinse afterward with warm water and wipe dry with a clean cloth.
* always follow safety instructions

it Pulire FENIX significa pulirne la struttura. Si può farlo, usando acqua tiepida. Poiché FENIX è un materiale resistente, si può utilizzare qualsiasi detergente per la casa, se necessario anche un solvente come l'acetone *. Tuttavia, per evitare di danneggiare la struttura, è consigliabile evitare di strofinarla usando una crema abrasiva, una spugna abrasiva o una spazzola con setole dure; nel tempo, ciò potrebbe portare alla formazione di un'area lucida sulla superficie opaca. Si può piuttosto utilizzare una spugna in melamina, nota anche come spugna magica. Come ultimo passaggio, per evitare la formazione di depositi nella struttura, che si tratti di sporco o residui del detergente, risciacquare sempre con acqua tiepida e asciugare con un panno pulito.
* seguire sempre le istruzioni di sicurezza.

TOP ACCESS
PASSACAVI

511PLUS

mara

DESCRIPTION / DESCRIZIONE

en **Aluminium top access with flap. Black brush.**

it Passacavi in alluminio con spazzola nera.

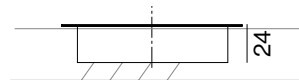
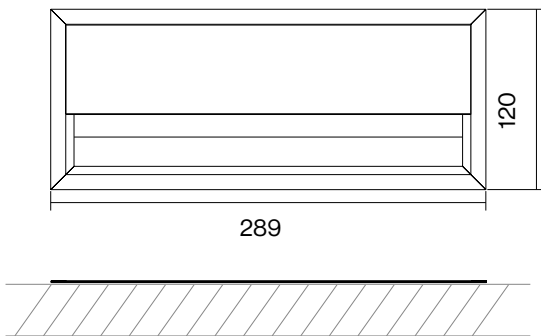

All measurements are indicated in mm
Tutte le misure sono indicate in mm

Surface cut-out area

Area di taglio della superficie

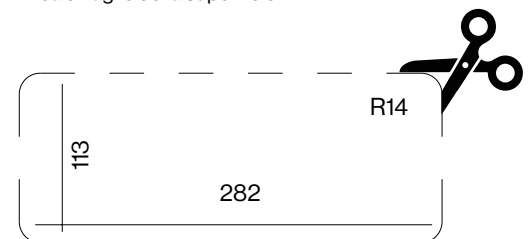

COLOURS AVAILABLE / COLORI DISPONIBILI



aluminium
alluminio



black
nero



REV052026

MARA SRL | Via Adua 11, 25050 Passirano (BS) Italy | T. +39 030 6857568 | marasrl.it

TOP ACCESS WITH INTEGRATED POWER UNIT
PASSACAVI CON MULTIPRESA INTEGRATA



511EPLUS

DESCRIPTION / DESCRIZIONE

en Top access with integrated power unit for table tops max 30 mm thick, available in aluminium or black colour, 289x120 mm with 2 mt. power cable + 2 DE sockets + 2 USB 5V/2, 4A + 2 RJ45 sockets.

it Passacavo con multipresa integrata per piani tavoli spessore max 30 mm, disponibile nei colori alluminio o nero, 289x120 mm con 2 mt. di cavo di alimentazione + 2 presa DE + 2 prese USB 5V/2, 4A + 2 prese RJ45.



Optional (on demand)*:
 Opzionali (su richiesta)*:

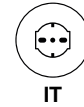

* dedicated quotation / quotazione dedicata

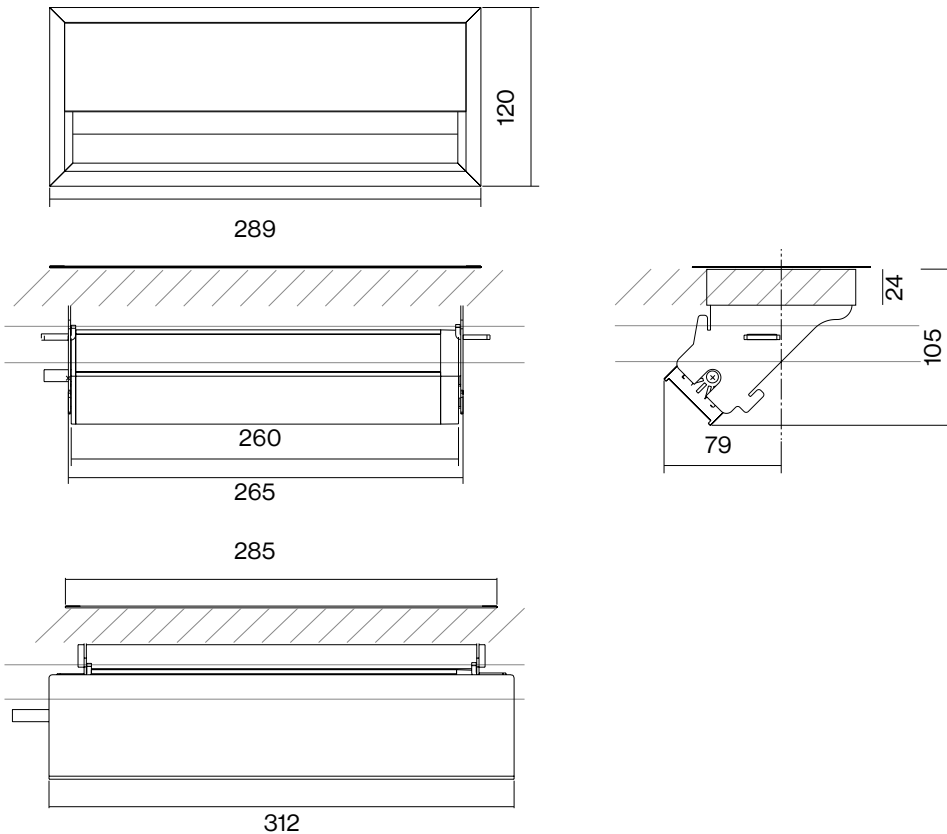

Surface cut-out area

Area di taglio della superficie

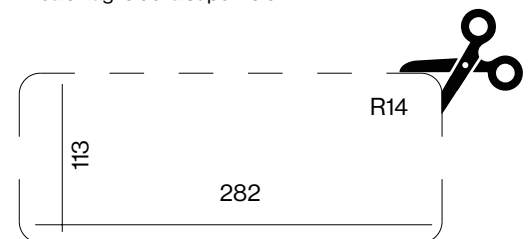

All measurements are indicated in mm
 Tutte le misure sono indicate in mm

COLOURS AVAILABLE / COLORI DISPONIBILI



aluminium
alluminio



black
nero



TOP ACCESS WITH INTEGRATED MULTIFUNCTIONAL SOCKET

PASSACAVI CON MULTIPRESA INTEGRATA

mara

PASD60

DESCRIPTION / DESCRIZIONE

en Top access round with integrated multifunctional socket for table tops, available in white or black colours, diameter 60 mm with 1,5 mt. cable + 1 DE + 1 USB A + 1 USB C DATA + 1 USB C RECHARGE SOCKETS WITH SCHUKO PLUG)

it Presa multifunzione rotonda per piani tavoli, disponibile nei colori bianco o nero, diametro 60 mm con cavo 1,5 mt. + 1 presa DE + 1 USB A + 1 USB C DATI + 1 USB C RICARICA (CAVO PRESA SCHUKO)

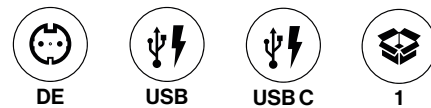

Optional (on demand)*:
Opzionali (su richiesta)*:

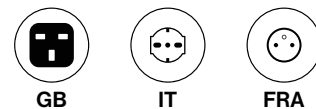

* dedicated quotation / quotazione dedicata

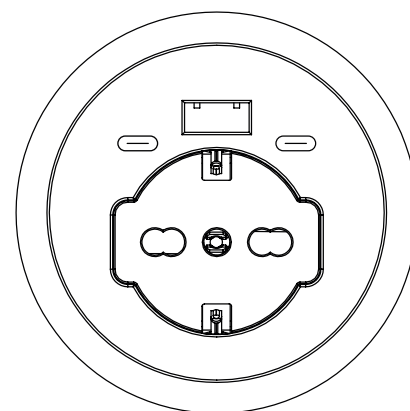
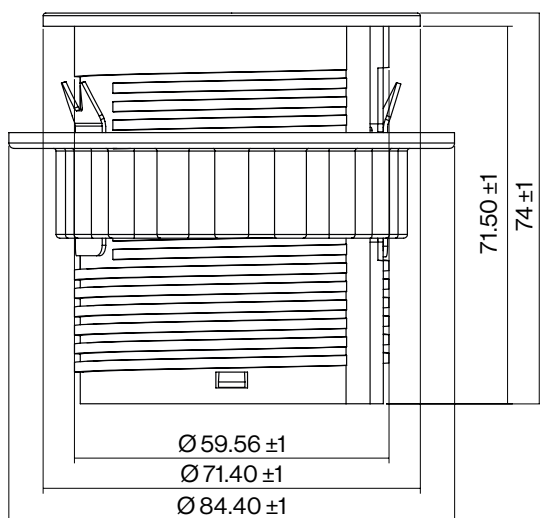

Surface cut-out area

Area di taglio della superficie

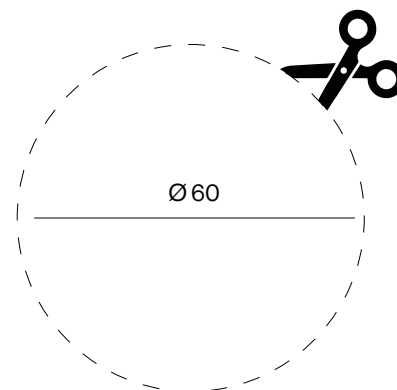

All measurements are indicated in mm
Tutte le misure sono indicate in mm

COLOURS AVAILABLE / COLORI DISPONIBILI

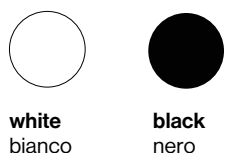

REV052026

MARA SRL | Via Adua 11, 25050 Passirano (BS) Italy | T. +39 030 6857568 | marasrl.it

CABLE MANAGEMENT WITH INTEGRATED MULTISOCKET PASSACAVO CON MULTIPRESA INTEGRATA

mara

PASD80

DESCRIPTION / DESCRIZIONE

en Top access round with integrated multifunctional socket for table tops, available in white or black colours, diameter 80 mm with 2 mt. power cable + 1 DE + 2 USB 5V/2, 4A socket + 1 RJ45 (interchangeable). The inside of the cover is equipped with a wireless charger (usable only when open).

it Presa multifunzione rotonda per piani tavoli, disponibile nei colori bianco o nero, diametro 80 mm con 2 mt. di cavo di alimentazione + 1 presa DE + 2 prese USB 5V/2, 4A + 1 presa RJ45 (intercambiabile). L'interno del coperchio è provvisto di caricatore wireless (utilizzabile solo quando aperto).



wireless
recharge



RJ45



DE



USB



1

**Optional
(on demand)*:**
Opzionali
(su richiesta)*:



HDMI



EXIT



GB



IT



FRA

* dedicated quotation and minimum order
* quotazione dedicata e minimo d'ordine

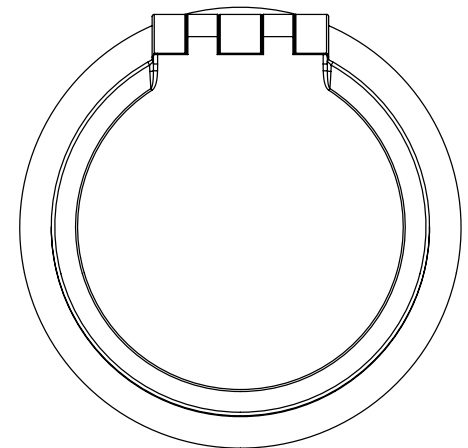
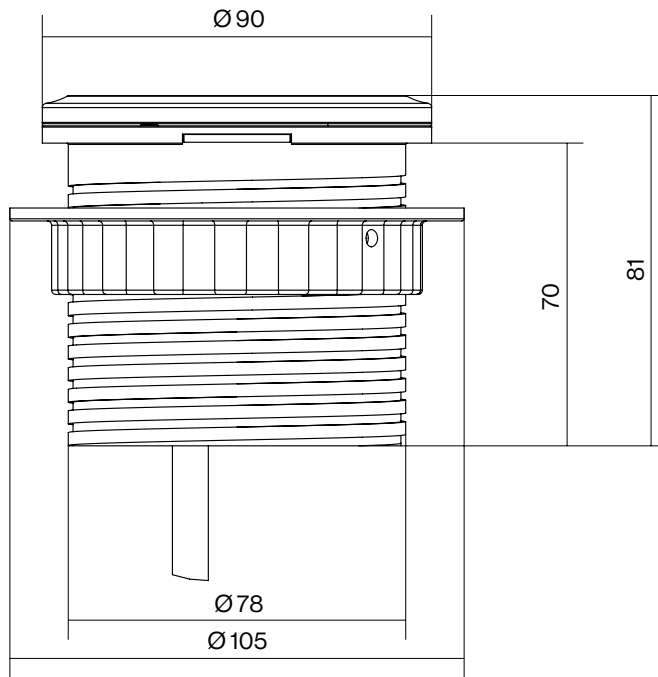

Surface cut-out area
Area di taglio della superficie

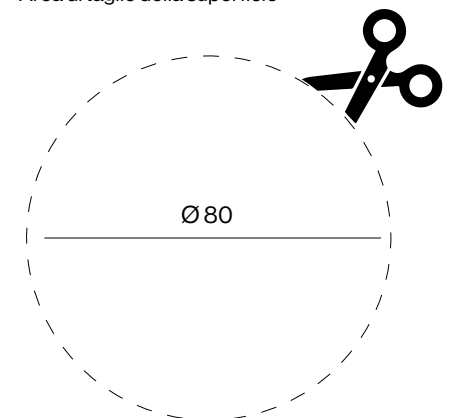

All measurements are indicated in mm
Tutte le misure sono indicate in mm

COLOURS AVAILABLE / COLORI DISPONIBILI



white
bianco



black
nero



REV052026

MARA SRL | Via Adua 11, 25050 Passirano (BS) Italy | T. +39 030 6857568 | marasrl.it

ACOUSTIC PANEL PANNELLO FONOASSORBENTE

mara

FP120x44 - FP180x44

DESCRIPTION / DESCRIZIONE

en The sound-absorbing panel made with Snowsound technology is an excellent solution for dividing worktops by creating a visual barrier and optimising acoustic comfort. Application to the surface using special clamps.

The panel has an Italian Class1 fire reaction and Euroclass B-s2, d0. The panel is 100% recyclable and has no detectable formaldehyde content according to UNI EN 717-2.

The panel has been tested in reverberation chamber according to UNI EN ISO 354 and obtained "Acoustic Absorption Class A", in accordance with UNI EN ISO 11654.

it Il pannello fonoassorbente realizzato con la tecnologia Snowsound è un'ottima soluzione per suddividere i piani di lavoro creando una barriera visiva ed ottimizzando il comfort acustico. Applicazione al piano mediante appositi morsetti.

Il pannello ha Classe1 Italia di reazione al Fuoco ed Euroclass B-s2, d0. Il pannello è riciclabile al 100% e ha un contenuto di formaldeide non rilevabile secondo la norma UNI EN 717-2.

Il pannello è stato testato in camera riverberante secondo la norma UNI EN ISO 354 ed ha "Classe di Assorbimento Acustico A", in accordo con la norma UNI EN ISO 11654.

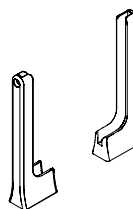
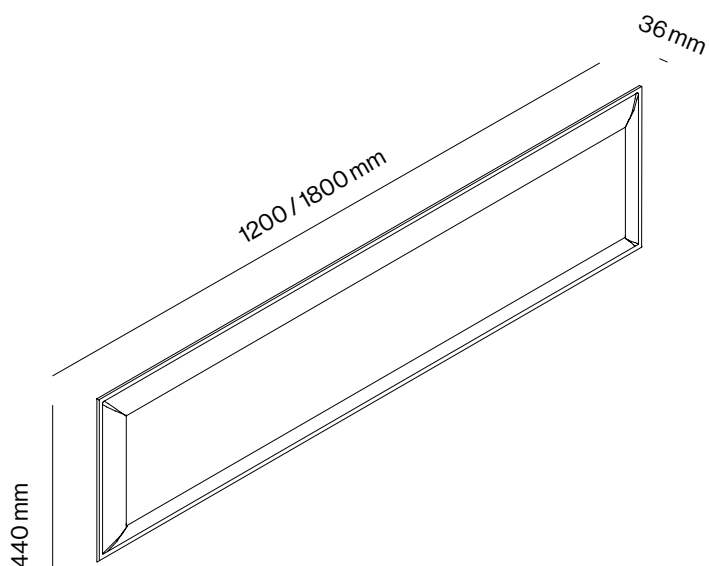

en Pair of brackets in powder-coated steel and zamac for connection to the desk top.

it Coppia attacchi in zama verniciati con polveri epossidiche per fissaggio al piano della scrivania.



kit 2 brackets
kit 2 attacchi
1 kg



1200 x 440 mm
1,6 kg



1400 x 440 mm
2,1 kg



1600 x 440 mm
2,6 kg



1800 x 440 mm
3,1 kg

fire-retardant fabric
tessuto ignifugo



8004



8007



8033



3008



7004



4027



4067



7074

FLEXIBLE CABLE MANAGEMENT

VERTEBRA FLESSIBILE IN RETE

mara

VERTEBRE

DESCRIPTION / DESCRIZIONE

en Flexible cable duct made of multifilament polyester, double slider zip, max. height 1300 mm, suitable for height-adjustable tables, complete with tabletop mounting plate and base with weight for greater stability

it Canalina flessibile realizzata in poliestere multifilamento, cerniera con doppio cursore, altezza max. 1300 mm, adatta a tavoli regolabili in altezza, completa di piastra di fissaggio al piano e base con peso per maggiore stabilità

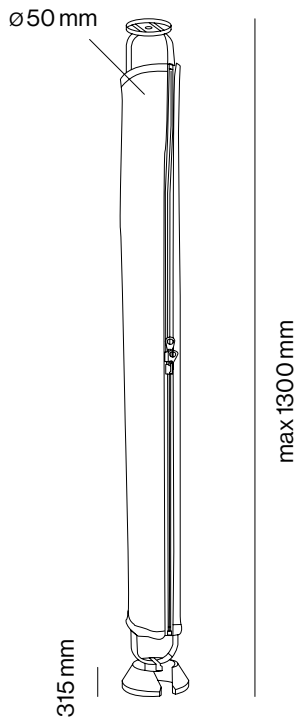

- Suitable for height-adjustable tables
- For table tops with a maximum height of 1300 mm
- Hinge with two sliders for opening from both the top and bottom
- Easy to attach to the table top with a single screw (included)
- Versatile thanks to the flexibility of the fabric

- Adatta a tavoli regolabili in altezza
- Per piani tavolo con altezza max. 1300 mm
- Cerniera con due cursori per apertura sia dall'alto che dal basso
- Fissaggio facilitato al piano tramite una sola vite (inclusa)
- Versatile grazie alla flessibilità del tessuto

Flexible multi-filament polyester fabric

Tessuto flessibile in poliestere multifilamento



Black
nero



aluminium
alluminio



white
bianco

en As it is always seeking to improve its products, the company reserves the right to modify or upgrade the products without prior notice, at any time. Colors should be considered purely indicative.
Mara's Collections are worldwide protected by the industrial property right and patents.

it Mara, sempre alla ricerca del miglioramento dei propri prodotti, si riserva la facoltà di apportare modifiche costruttive e funzionali in qualsiasi momento senza alcun preavviso. I colori dei materiali sono da ritenersi puramente indicativi. Tutte le collezioni Mara sono protette nel mondo dal diritto di proprietà industriale e da brevetti registrati.