

**DESCRIPTION / DESCRIZIONE**

**en** The Aera seating collection stands out for its careful balance between minimalist form and meticulous attention to detail: a line that stretches, a structure that tapers, an object that seems to transcend its material form whilst retaining its solidity and functionality Aera is designed as a comprehensive range, capable of adapting to a wide variety of settings, from restaurants and communal spaces to workplaces and the more intimate settings of the home.

**it** La collezione di sedute Aera si distingue per un equilibrio calibrato tra essenzialità formale e ricerca del dettaglio: una linea che si tende, una struttura che si assottiglia, un oggetto che sembra sottrarsi alla materia pur mantenendo solidità e funzione. Una presenza visiva leggera, quasi sospesa, capace di dialogare con l'architettura senza sovrapporsi. Aera si sviluppa come una famiglia completa, capace di adattarsi a molteplici scenari d'uso, dalla ristorazione agli spazi collettivi, dagli ambienti di lavoro fino alle atmosfere più intime dell'abitare.

**AERA SLED ARMCHAIR**

**Sled armchair**

Poltroncina a slitta

**2150**

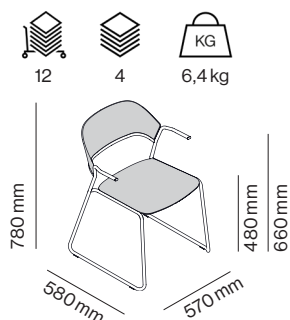
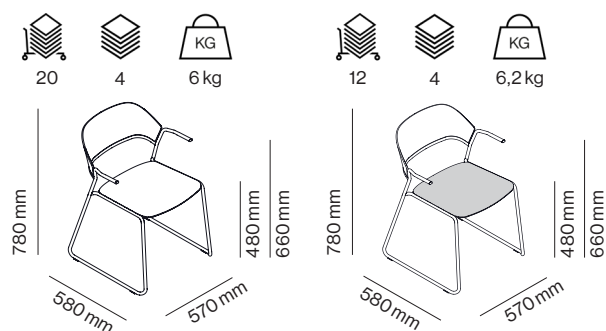

**outdoor version**  
versione outdoor



**fire retardant upholsteries**  
rivestimenti ignifughi



**fire retardant polypropylene version**  
versione in polipropilene ignifugo

**ACCESSORIES**  
/ ACCESSORI

**506**



**trolley (max 8 pcs)**  
carrello

SUSTAINABILITY SHEET / SCHEDA DI SOSTENIBILITÀ

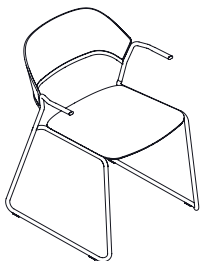

MATERIALS USED\* / MATERIALI UTILIZZATI\*

en Aera Sled Armchair is made of materials that can be recycled or reused so to reduce wastes.

it Aera Sled Armchair è stata progettata affinché tutti i materiali utilizzati possano essere riciclati o riutilizzati a fine vita, riducendo gli sprechi.



**Recycled materials**  
Materiali riciclati

**> 16 %**



**Total weight**  
Peso totale

**6 kg**



**Disassembly**  
Disassemblabilità

**> 99 %**

**Steel weight**  
Peso acciaio

**3,94 kg**

**Powder coating**  
Verniciatura a polvere

**0,06 kg**



**Recyclable materials**  
Materiali riciclabili

**> 98 %**

**PP weight**  
Peso PP

**2 kg**

OTHER INFORMATION / ALTRE INFORMAZIONI

en The automations implemented in the production of Aera Sled Armchair involve minimal energy consumption and emissions aimed at the lowest possible environmental impact.

it Le automazioni messe in atto per la produzione di Aera Sled Armchair prevedono assorbimenti energetici ed emissioni minime finalizzate al più basso impatto ambientale possibile.



**Renewable energy adopted for production**  
Energia rinnovabile utilizzata per la produzione

**> 99%**

**Spare parts availability**  
Disponibilità di ricambi

**> 10  
years / anni**



**Powder coating VOC emission**  
Emissione di VOC vernice a polvere

**0%**

**Durability design**  
Progettato per durare nel tempo

**> 15  
years / anni**



**Made in Italy parts**  
Componenti Made in Italy

**> 99%**

**SHELL / SCOCCA**

**polypropylene**  
polipropilene

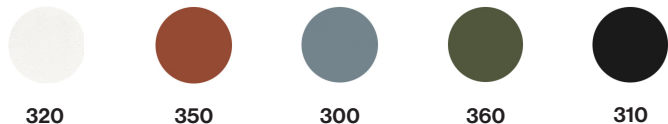

**fire retardant polypropylene**  
polipropilene ignifugo

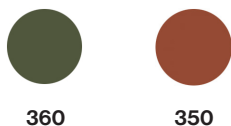

**FRAME / STRUTTURA**

**powder coated steel**  
acciaio verniciato

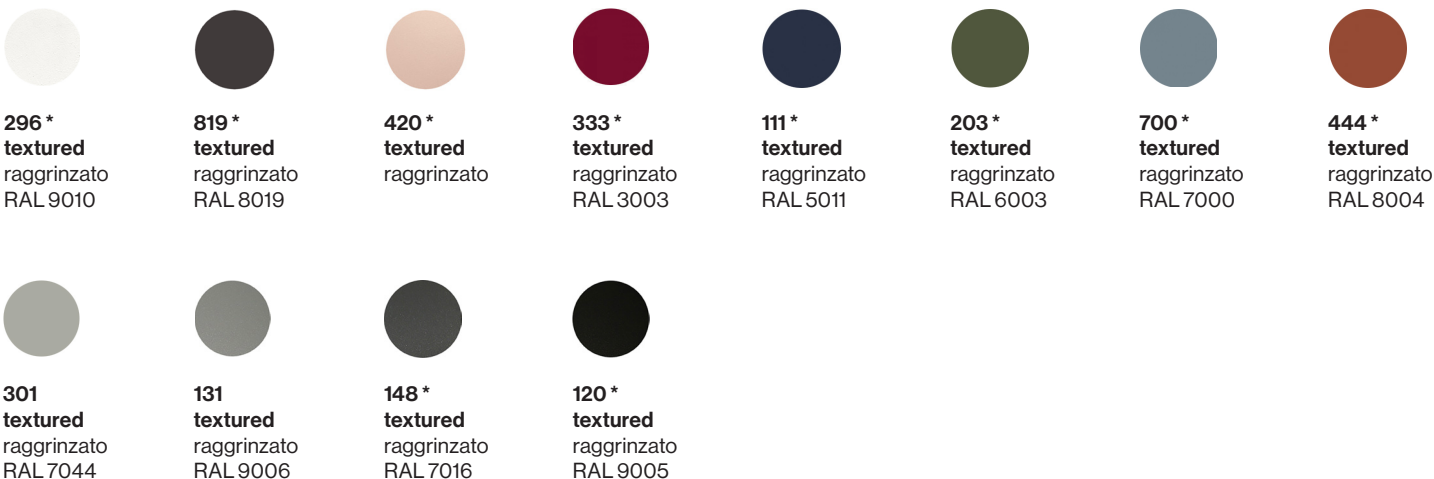

\* available for outdoor version  
\* disponibile per versione outdoor



**ecological chromed steel**  
acciaio cromato ecologico



**eco-chrome**  
cromo ecologico

**en** Our types of metals include: chromed metals and painted metals. Do not use acid or alkaline based cleaning products. Do not use detergents, steel wool, dishwashing detergents or the like. Sharp or pointed objects may damage the surface. Any hot or wet object may cause surface damage. Clean the surface regularly with a soft cloth to remove dust. To remove light dirt, use a soft cloth and a neutral household cleaner.

**it** Le nostre tipologie di metallo comprendono: metalli cromati e metalli verniciati. Non utilizzare prodotti per la pulizia a base acida o alcalina. Non utilizzare detersivi, lana di acciaio, detersivi per stoviglie o simili. Oggetti appuntiti o taglienti possono danneggiare la superficie. Qualsiasi oggetto caldo o bagnato potrebbe provocare danni alla superficie. Pulire la superficie regolarmente con un panno soffice per rimuovere la polvere. Per rimuovere lo sporco leggero utilizzare un panno soffice e un prodotto per le pulizie di casa neutro.

UPHOLSTERIES / RIVESTIMENTI

CAT. D, ZERO - KVADRAT

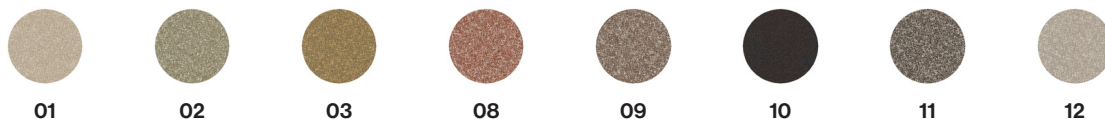

COMPOSITION / COMPOSIZIONE

65% cotton 20% polyacrylic 15% polyester

WEIGHT / PESO

740 g/m lin. (23,87 oz/ly)

ABRASION RESISTENCE / RESISTENZA ABRASIONE

Approx. 70.000 Rubs Martindale (EN ISO 12947)

TEST / TEST

note 5, EN ISO 12945 • Seam parallel to warp: 2.0 mm, parallel to weft: 2.0 EN ISO 13936-2 180 Newton • Note 5-6 ISO 105-B02 • Dry note 4-5 ISO 105-X12, Wet note 4-5 ISO 105-X12 • AS/NZS 3837 Class 2, BS 5852 Crib 5 with treatment, BS 5852 part 1 with treatment, EN 1021-1, US Cal. Bull. 117-2013 with cAL.117 compliant interliner • US Cal. Bull. 117-2013 with Cal. 117 compliant interliner • AATCC8 Dry Croking: Grade 4.5, Wet Croking: Grade 4 • AATCC

16 Grade 5 min. 40h • Pilling Clas 5.0, Breaking Strenght ASTM D5034 warp 159 / weft 113 lbs, Seam Slippage ASTM D4034 warp 91 / weft 22 lbs • ASTM D4966 70.000 cycles Martindale - High Traffic.

CLEANING RULES / NORME DI PULIZIA

**Vacuum frequently, ideally every week, at half power where appropriate. Wipe upholstery fabrics made from polyurethane with a dry or moist cloth. May also be vacuum cleaned with a soft brush. Disinfection, see kvadrat.dk**

Passare spesso l'aspirapolvere ove opportuno, se possibile ogni settimana, a potenza intermedia. Pulire i tessuti per tappezzeria in poliuretano con un panno asciutto o umido o anche usando un aspirapolvere con spazzola morbida. Disinfezione, vedi kvadrat.dk

CAT. D, VERA PELLE, PRIMALINEA - MASTROTTO

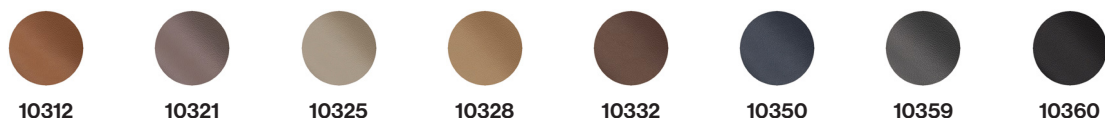

COMPOSITION / COMPOSIZIONE

100% Nappa

ABRASION RESISTENCE / RESISTENZA ABRASIONE

50.000, UNI EN ISO 5402 - No damage

TEST / TEST

Tear strength (single edge tear) UNI EN ISO 3377-1 N  $\geq$  20 • Colour fastness to rubbing (dry, 500 cycles) UNI EN ISO 11640:1998 Grey scale  $\geq$  4 • Colour fastness to rubbing (wet, 250 cycles) UNI EN ISO 11640:1998 Grey scale  $\geq$  4 • Colour fastness to rubbing (sweat, 80 cycles) UNI EN ISO 11640:1998 ISO 11641 pH8 Grey scale  $\geq$  4 • Finish adhesion (dry) UNI EN ISO 11644 N/cm  $\geq$  2 • Color fastness to artificial light (exp. energy 16.000 kJ/sqm) UNI EN ISO 105 B02 (MET. 5) Blue scale  $\geq$  5 • Smolder resistance, cigarette and match flame CAL TB-117 (2013, Sec. 1) BS 5852: 1979, source 0-1 BS EN 1021-1-2:2006-Pass • Measurement of antibacterial activity on non-porous surfaces ISO 22196 Anti-bacterial efficacy • Test method to assess antibacterial activity

ISO 16187 Anti-bacterial efficacy • Standard test method for determining the antimicrobial activity of antimicrobial agents under dynamic contact conditions ASTM E 2149 Anti-bacterial efficacy • Standard test method for determining the activity of incorporated antimicrobial agent(s) in polymeric or hydrophobic materials ASTM E 2180 Anti-bacterial efficacy • Determination of antiviral activity ISO 18184 Anti-viruses efficacy

CLEANING RULES / NORME DI PULIZIA

**Avoid direct sunlight. Avoid exposure to heat sources.**

Evitare la luce diretta del sole. Evitare l'esposizione alle fonti di calore.

FIRE RETARDANT UPHOLSTERIES / RIVESTIMENTI IGNIFUGHI



CAT. C, REMIX 3 - KVADRAT



**COMPOSITION / COMPOSIZIONE**

90% new wool, 10% nylon

**WEIGHT / PESO**

420 g/lin.m, 13.6 oz/ly

**ABRASION RESISTENCE / RESISTENZA ABRASIONE**

100.000 Martindale rubs, EN ISO 12947

**FIRE RETARDANT TEST / TEST IGNIFUGO**

AS/NZS 1530.3 • BS 5852 crib 5 with treatment • BS 5852 part 1 • IMO FTP Code 2010 Part 7 with treatment • IMO FTP Code 2010 Part 8 • NF D 60 013 • NFPA 260 • SN 198 898 5.3 with treatment • UNI 9175 1IM • US Cal. Bull. 117-2013 • EN 1021-1/2 • AS/NZS 3837 class 2 • ÖNORM B1/Q1 • ASTM E84 Class A Unadhered • ASTM E84 Class A Adhered • GB 50222 B1 with treatment (Chinese) • EN 13501 B-s2, d0 with treatment

**CLEANING RULES / NORME DI PULIZIA**

**Vacuum clean frequently, ideally every week. Remove stains as soon as they occur, with clean warm water or sparkling water. Extraction clean when necessary. Extraction cleaning might dissolve water-based glue. Pay attention to temperature and amount of cleaning fluid. Disinfection, see kvadrat.dk**

Passare spesso l'aspirapolvere, possibilmente ogni settimana. Rimuovere le macchie non appena si formano, con acqua calda pulita o acqua calda o frizzante. Pulire a estrazione quando necessario. La pulizia a estrazione può sciogliere la colla a base d'acqua. Prestare attenzione alla temperatura e alla quantità di liquido detergente. Disinfezione, vedi kvadrat.dk

CAT. C, FIELD 2 - KVADRAT

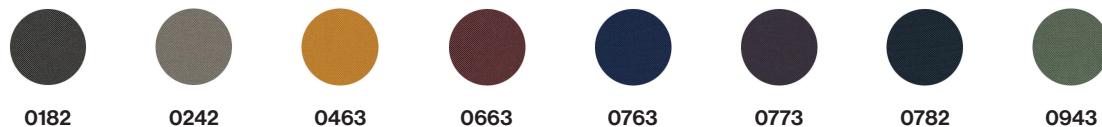

**COMPOSITION / COMPOSIZIONE**

100% Trevira CS

**WEIGHT / PESO**

450 g/lin. m (14.51 oz/ly)

**ABRASION RESISTENCE / RESISTENZA ABRASIONE**

80.000 Rubs Martindale (EN ISO 12947)

**FIRE RETARDANT TEST / TEST IGNIFUGO**

NF D 60 013 • US Cal. Bull. 117-2013 • NFPA 701 • BS 5852 Crib 5 • EN 1021-1/2 • AS/NZS 3837 class 1 • IMO FTP Code 2010 Part 8 • DIN 4102 B1 • NF P 92 507 M1 • FAR 25.853 • UNI 9175 1IM • UNI 9177 Classe 1 • BS 5867 part 2 type B • SN 198 898 5.2 • EN 13501-1, B-s1, d0 • ÖNORM B1/Q1 • CAN ULC S102 • CAN ULC S109 • IMO FTP Code 2010 Part 5 • GB 8624 B1 • ASTM E84 Class A Unadhered

**CLEANING RULES / NORME DI PULIZIA**

**Vacuum clean frequently, ideally every week. Remove stains as soon as they occur, with clean warm water or sparkling water. Extraction clean when necessary. Extraction cleaning might dissolve water-based glue. Pay attention to temperature and amount of cleaning fluid. Disinfection, see kvadrat.dk**

Passare spesso l'aspirapolvere, possibilmente ogni settimana. Rimuovere le macchie non appena si formano, con acqua calda pulita o acqua calda o frizzante. Pulire a estrazione quando necessario. La pulizia a estrazione può sciogliere la colla a base d'acqua. Prestare attenzione alla temperatura e alla quantità di liquido detergente. Disinfezione, vedi kvadrat.dk

**AERA SLED ARMCHAIR** / design Marcello Ziliani  
2150

**mara**

**CAT. C, CAPTURE - GABRIEL**



3001



3601



3701



3801



4601



5101



6601



7401

**COMPOSITION / COMPOSIZIONE**

85% New Zealand wool, 15% Polyamide

**WEIGHT / PESO**

475 g/lm — 15.32 oz./lin.yd

**ABRASION RESISTENCE / RESISTENZA ABRASIONE**

200,000 — rubs martindale (EN ISO 12947-2)

200,000 — rubs martindale (ASTM D4966) (heavy duty upholstery)

**FIRE RETARDANT TEST / TEST IGNIFUGO**

BS EN 1021 1&2 Cigarette and Match • BS 5852 Part 10,1 Cigarette & Match, The Furniture and Furnishing Regulations 1988 • Class Uno UNI 9175 Class 1 EMME • CA TB 117-2013 • ASTM E 84 Class 1

**FIRE RETARDANT UPHOLSTERIES / RIVESTIMENTI IGNIFUGHI**

CAT. C, CAPTURE - GABRIEL

4601510166017401

3001360137013801

**CLEANING RULES / NORME DI PULIZIA**

**Always follow the manufacturer's instructions and finish by wiping with a damp cloth.**

Seguire sempre le istruzioni del produttore e finire con un panno umido.

**CAT. B, BOUCLÉ**



911



913



904



307



400



201



707



600



502



801

**COMPOSITION / COMPOSIZIONE**

100% Polyester with FR backing

**WEIGHT / PESO**

1020 g/ml +/- 8%

**ABRASION RESISTENCE / RESISTENZA ABRASIONE**

ISO 12947-2 / ≥80.000 cicli / rubs martindale • ASTM D4157 / ≥80.000 cicli / rubs martindale

**CERTIFICATIONS / CERTIFICAZIONI**

EN 1021/1 (cigarette) - 2 (match) • BS 5852-1 (cigarette) - (match) • BS 5852 (CRIB 5) UNI 9175, classe 1 • IM CAL TB 117 NFPA 260 • IMO 2010 FTP part 8 ISO 105 - B02 / ≥4-5 (scale 1-8) • AATCC 16.3 / (40 afu) / ≥3-4 (scale 1-5)

• ISO 12945 / ≥4-5 (scale 1-5) • ISO 105 x 12 / dry ≥4-5 / wet ≥3-4 (scale 1-5) • AATCC 8 / dry ≥4-5 / wet ≥3-4 (scale 1-5) ISO 105 - E03 / (scale 1-5) ISO 105 - E02 / (scale 1-5) • ISO 13936 - 2 / warp ≤6,00 mm. / weft ≤6,00 mm. • ASTM D4034 / ≥60 lbs.

**CLEANING RULES / NORME DI PULIZIA**

**Vacuum regularly with a smooth nozzle, without brushing.**

Usare con regolarità l'aspirapolvere a beccuccio liscio, senza spazzolare.

**AERA SLED ARMCHAIR / design Marcello Ziliani**  
2150

**mara**

**CAT. B, STEP MELANGE - GABRIEL**



60004



60011



60021



67007



65090



64159



68120



65011

**COMPOSITION / COMPOSIZIONE**

100% Trevira cs

**WEIGHT / PESO**

470 g/lm, 15,16 oz/lin.yd

**ABRASION RESISTENCE / RESISTENZA ABRASIONE**

100.000 rubs martindale (EN ISO 12947-2), 100,000 double rubs wyzenbeek (ASTMD4157-07) (heavy duty upholstery)

**FIRE RESISTANCE / RESISTENZA AL FUOCO**

DIN 4102 - B1 • NFP 92-503/504/505 M1 • BS EN 1021 1&2 Cigarette and Match • BS EN 1021-1 Cigarette • BS 5852 Crib 5 • ÖNORM A3800-B1-B3825-Q1 UK • FAR/JAR 25.853 (a) (i) (ii) • AM 18 - NFD 60-013-(only for fabric) • CA TB 117-2013 • Class Uno UNI 9175 Class 11 EMME • DIN EN 13501-1 B-s1,d0 • IMO MSC 307(88) Annex 1 part 8 • MED Certificate IMO • IMO MSC 307(88) Annex 1 part 8 UK • MED Certificate IMO UK • CAN/ULC-S102.2 • CAN/ULC-S 109

**CLEANING RULES / NORME DI PULIZIA**

**Step Melange is made of Trevira CS which is a polyester material suited for environments with special requirements for cleaning. Can be wiped with Virkon S, Actichlor Plus, Prime Source ren-93 or Ethanol (70-85%). Always follow the manufacturer's instructions and finish by wiping with a damp cloth.**

Step Melange è realizzato in Trevira CS, un materiale in poliestere adatto ad ambienti con particolari esigenze di pulizia. Può essere pulito con Virkon S, Actichlor Plus, Prime Source ren-93 o etanolo (70-85%). Seguire sempre le istruzioni del produttore e finire con un panno umido.

**CAT. B, FENICE - PUGI**



601



602



603



452



301



505

**COMPOSITION / COMPOSIZIONE**

75% WO 25% PA

**WEIGHT / PESO**

335 ± 7% / 500 ± 7% gr./m<sup>2</sup>-gr./mtl.

**ABRASION RESISTENCE / RESISTENZA ABRASIONE**

100.000 ± 20% cicli (UNI EN ISO 12947)

**CERTIFICATIONS / CERTIFICAZIONI**

Misura del coefficiente di assorbimento acustico UNI EN ISO 354:2003 • Rapporto di misura del coeff. di assorbimento acustico UNI EN ISO 10534-2 • Rapp.di Prova Classe 1IM-con schiuma standard ignifuga con densità 25 kg3 • BS 5852 Crib N°5 with standard Foam 20/22 Kg/cu.m-CON TRATT. A RICHIESTA • EN 1021 Part 1-2 using a standard Foam 20/22 Kg/cu.m. • Calif. Bull.117 June 2013

**CLEANING RULES / NORME DI PULIZIA**

**Vacuum regularly with a smooth nozzle, without brushing.**

Usare con regolarità l'aspirapolvere a beccuccio liscio, senza spazzolare.

**AERA SLED ARMCHAIR** / design Marcello Ziliani  
2150

**mara**

Cat. A, VELVET



14406



16430



16040



14423



16610



14438



16425

**COMPOSITION / COMPOSIZIONE**

100% inherent FR polyester

**WEIGHT / PESO**

Weight 325 g/m<sup>2</sup> | 9.59 oz/yd<sup>2</sup> • Width 138-140 cm | 54" • Piece length ± 49 m | 53 yd • Dye batch length ± 200 m | 218 yd

**ABRASION RESISTENCE / RESISTENZA ABRASIONE**

50.000 cycles MARTINDALE

**CERTIFICATIONS / CERTIFICAZIONI**

Breaking strength ISO 13934-1 Warp 1200N Weft N 820N • Tear resistance

EN ISO 13937-3 Of the warp 49N Of the weft 37N • Seam slippage ISO 13936-2 Warp 1.50 mm Weft 1.00 mm • Abrasion resistance ISO 12947-2 Colour degradation at 3000 rubs 4 - 5 Complete wear out 60.000 rubs • Colour fastness to light EN ISO 105 B02 Colour 5 - 6 • Colour fastness to rubbing EN ISO 105-X12 Dry 4 - 5 Wet 4 - 5 • Fastness to water EN ISO 105-E01 Colour 4 • Dimensional change in domestic washing and drying EN ISO 5077 Warp 0.5 % EN ISO 6330 Weft 0.5 %

**CLEANING RULES / NORME DI PULIZIA**

**Clean with damp soapy cloth and rinse well with clean water. Do not use solvents, bleaches, synthetic detergents, polishes or aerosol spray.**

Pulire con tessuto inumidito ed insaponato e sciacquare bene con acqua pulita. Non usare solventi, candeggine e detergenti chimici o spray per lucidare.

CAT. A, ECO-LEATHER GAZEBO - LEDERPLAST



06



151



1194



6986



4981



726



991

**COMPOSITION / COMPOSIZIONE**

87,5 % P.V.C. Plastificato, 8,1 % Poliestere, 4,4 % Cotone

**WEIGHT / PESO**

640 ± 50 g/m<sup>2</sup> (UNI EN 2286-2:2001)

**ABRASION RESISTENCE / RESISTENZA ABRASIONE**

300.000 cicli (UNI EN ISO 5470-2:2004)

**FIRE RESISTANCE / RESISTENZA AL FUOCO**

UNI 9175: 2010 Reaction ignition of upholstered furniture exposed to a small flame CLASS 1IM • BS 1021-1: 2014 Assessment of the ignitability of upholstered furniture – Part 1: Ignition source smouldering cigarette • BS 1021-1: 2014 Assessment of the ignitability of upholstered furniture – Part 2: Ignition source match flame equivalent • BS 5852 parte 1: 1979 Match flame equivalent test • The material complies with the requirements of BS 7176:

2007+A1: 2011 for the hazard category LOW HAZARD • California Technical Bulletin 117:2013 • IMO Resolution MSC.307(88) - FTP CODE 2010 – PART 8 • AFNOR NF P 92.503 – M2 • ISO 3795: 1989 • FAR 25.853 Part 25 Appendix F Vertical test Par (a) (1) (ii)

**CLEANING RULES / NORME DI PULIZIA**

**Clean with damp soapy cloth and rinse well with clean water. Do not use solvents, bleaches, synthetic detergents, polishes or aerosol spray.**

Pulire con tessuto inumidito ed insaponato e sciacquare bene con acqua pulita. Non usare solventi, candeggine e detergenti chimici o spray per lucidare.

**AERA SLED ARMCHAIR / design Marcello Ziliani**  
2150

**mara**

CAT. A, MIRAGE - PUGI



629



625



651



379



332



234



231



533



53



426

**COMPOSITION / COMPOSIZIONE**

100% PLFR (Tr Cs)

**WEIGHT / PESO**

330 ± 10% / 460 ± 10% gr./m<sup>2</sup>-gr./mtl.

**ABRASION RESISTENCE / RESISTENZA ABRASIONE**

100.000 ± 20% cicli (UNI EN ISO 12947:2000)

**CERTIFICATIONS / CERTIFICAZIONI**

Rapporto di misura della resistenza al flusso d'aria secondo la norma ISO 9053-2 • Classe 1 Sipari, Drappeggi, Tendaggi Classe 1IM - Rapporto di prova • EN ISO 6940/6941: BS 5852 Crib N°5 using a CM Foam 35 Kg/cu.m. • B1 DIN 4102. • EN 1021 Part 1-2 using a CM Foam 35 Kg/cu.m. • EN 13773 Burning Behaviour: Class 1 • EN 13501-1 esp 1,2: B-s1, • Calif.Bull.117 June 2013 • Fire Protection Classification: 5.3 • M1 + NF D 60-013:2006 AM18 • FAR.25853 Classification: yes • B1 - OENORM 3800 PART 1 + OENORM B3825 • Azimut • MED/3.19 MED/3.21: Draperies, Curtains and Bedding comp • MED annex A.1 item:A.1/3.20 Upholstered Furniture

**CLEANING RULES / NORME DI PULIZIA**

**Vacuum regularly with a smooth nozzle, without brushing.**

Usare con regolarità l'aspirapolvere a beccuccio liscio, senza spazzolare.

**en** As it is always seeking to improve its products, the company reserves the right to modify or upgrade the products without prior notice, at any time. Colors should be considered purely indicative.

**Mara's Collections are worldwide protected by the industrial property right and patents.**

**it** Mara, sempre alla ricerca del miglioramento dei propri prodotti, si riserva la facoltà di apportare modifiche costruttive e funzionali in qualsiasi momento senza alcun preavviso. I colori dei materiali sono da ritenersi puramente indicativi.

Tutte le collezioni Mara sono protette nel mondo dal diritto di proprietà industriale e da brevetti registrati.